

AKOCONTROL

The most suitable range
of temperature and humidity control



Thermometers

Range from -50°C to +99°C, panel mounting, small format



C  US

Small dimensions 66 x 32 x 56 mm.

The size of the panel cut-outs make them exchangeable with the traditional mechanical thermometers.

Password enabled for entering programming, indication in °C or °F programme-selectable and probe calibration.

Application: Industrial and commercial cold, displays, cabinets, etc.

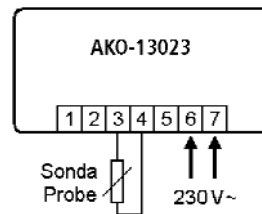

- Temperature range -50°C to +99°C
- Display 2 Digits (°C/°F)
- Resolution 1°C
- Accuracy ±1°C
- NTC probe
- Panel cut-out dimensions 25.4 x 58 mm
- Front dimensions 32 mm x 66 mm
- Depth 51 mm

Reference	Description	Family	Pack
AKO-13012	12V~, °C / °F per programme, probe 1.5 m	1510	12 Units
AKO-13020	120V~, °C / °F per programme, probe 1.5 m	1510	12 Units
AKO-13023	230V~, °C / °F per programme, probe 1.5 m	1510	12 Units

Thermostats

Range from -50°C to +99°C, 1 relay, panel mounting, small format



C  US

Small dimensions 66 x 32 x 56 mm.

The dimensions of the panel cut-out make them exchangeable with traditional mechanical thermometers, by also integrating the thermostat and defrost clock function in a single unit. Programmable for cold and heat. Defrost by compressor stop. Possible password for entering programming, indication in °C or °F programme-selectable and probe calibration.

Application: Industrial and commercial cold, displays, cabinets, etc.

- Temperature range -50°C to +99°C
- Display 2 Digits (°C/°F)
- Resolution 1°C
- Accuracy ±1°C
- NTC probe
- Panel cut-out dimensions 25.4 x 58 mm
- Front dimensions 32 x 66 mm
- Depth 51 mm

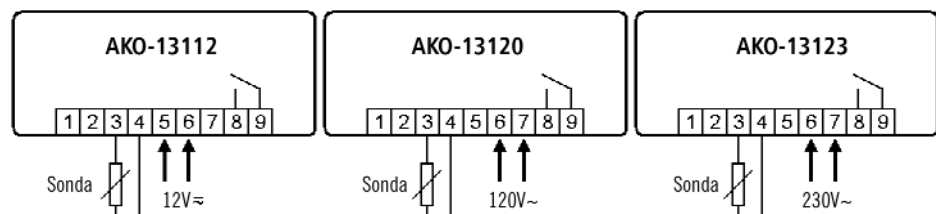

Reference	Description	Family	Pack
AKO-13112	12V~, relay SPST 16A, NTC probe included	1510	12 Units
AKO-13120	120V~, relay SPST 16A, NTC probe included	1510	12 Units
AKO-13123	230V~, relay SPST 16A, NTC probe included	1510	12 Units

Thermometers Range from -50°C to +150°C, panel mounting



Temperature display.

Temperature display in cold and heat applications. The AKO-14031 allows probe calibration, display in °C or °F and password programming to enter programming.

Application: Industrial and commercial cold, displays, incubators, vehicles, etc.

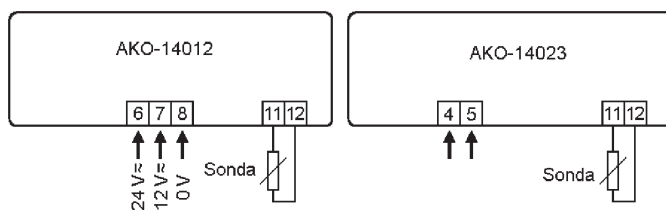

- With NTC probe, temperature range from -50.0°C to +99.9°C
- With PTC probe, temperature range from -50.0°C to +150°C
- 3-digit display (°C/°F)
- Resolution 0,1°C
- Accuracy ±1 °C
- NTC probe
- Panel cut-out dimensions 70.5 x 28.5 mm
- Front part dimensions 75.8 x 33.8 mm
- Depth 61 mm
- Power supply 230V~ ±10%, 50/60 Hz

Reference	Description	Family	Pack
AKO-14012	12/24V~, probe 1.5 m	1510	12 Units
AKO-14023	230V~, probe 1.5 m	1510	12 Units

Thermostats Range from -50°C to +150°C, 1 relay output, panel mounting



Programmable for cold and heat.

Display and control with decimal point. NTC or PTC probe selectable program. Password enabled for entering programming, indication in °C or °F programme-selectable and probe calibration. Defrost by compressor stop.

Application: Industrial and commercial cold, displays, incubators, etc

- With NTC probe, temperature range from -50.0°C to +99.9°C
- With PTC probe, temperature range from -50.0°C to +150°C
- Temperature range -50.0°C to +99.9°C
- Temperature range -50.0°C to +150°C
- Display 3 Digits (°C/°F)
- Resolution 0.1 °C
- Accuracy ±1°C
- Panel cut-out dimensions 70.5 x 28.5 mm
- Front part dimensions 75.8 x 33.8 mm
- Depth 61 mm

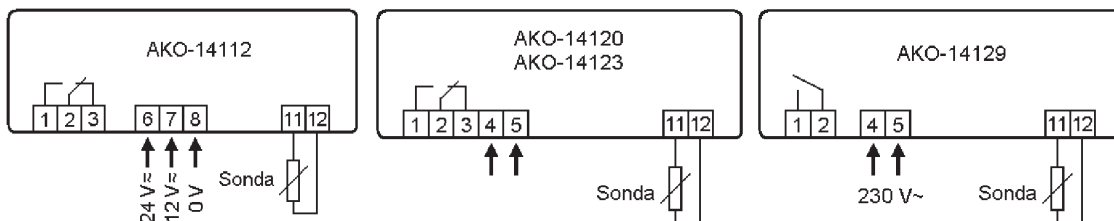

Reference	Description	Family	Pack
AKO-14112	12/24V~, 1 relay SPDT 16A, 1 NTC probe included	1510	12 Units
AKO-14120	120V~, 1 relay SPDT 16A, 1 NTC probe included	1510	12 Units
AKO-14123	230V~, 1 relay SPDT 16A, 1 NTC probe included	1510	12 Units
AKO-14129	230V~, 1 relay SPDT 18A, 1 NTC probe included	1510	12 Units

Temperature controllers Range from -50°C to +99°C, 2 relays, panel mounting



Defrost by electric heat or air.

The 2nd relay allows one of the following options to be regulated:

- Defrost by electric heat
- Defrost by hot gas bypass
- Defrost by air

With a 2nd optional probe, it enables defrost by temperature.

Possible password for entering programming, indication in °C or °F programme-selectable and probe calibration.

Application: Industrial and commercial cold, displays, electrical panels, etc.

- Temperature range -50°C to +99°C
- Display 3 Digits (°C/°F)
- Resolution 0.1°C
- Accuracy ±1 °C
- NTC probe
- Panel cut-out dimensions 70.5 x 28.5 mm
- Front part dimensions 75.8 x 33.8 mm
- Depth 61 mm
- Compressor relay SPST 16A, 250V, cosφ= 1
- Relay R2 SPDT 8A, 250V, cosφ= 1

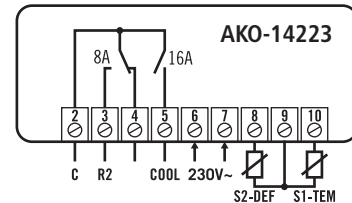
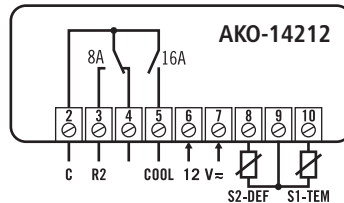

Reference	Description	Family	Pack
AKO-14212	12V~, 2 relays (one 16A), 1 NTC probe included	1510	12 Units
AKO-14220	120V~, 2 relays (one 16A), 1 NTC probe included	1510	12 Units
AKO-14223	230V~, 2 relays (one 16A), 1 NTC probe included	1510	12 Units

Temperature controllers Range from -50°C to +99°C, 3 relays, panel mounting



Defrost by electric heat, air or hot gas bypass.

Programmable defrost by regulating the compressor, resistances (or hot gas bypass) and fans. With a 2nd optional probe allowing defrost by temperature.

Possible password for entering programming, indication in °C or °F programme-selectable and probe calibration.

Application: Industrial and commercial cold, displays, electrical panels, etc.

- Temperature range -50°C to +99°C
- Display 3 Digits (°C/°F)
- Resolution 0.1°C
- Accuracy ±1°C
- NTC probe
- Panel cut-out dimensions 70.5 x 28.5 mm
- Front part dimensions 75.8 x 33.8 mm
- Depth 61 mm
- Compressor relay SPST 16A, 250V, cosφ= 1
- Fan relay SPST 6A, 250V, cosφ= 1
- Defrost relay SPDT 8A, 250V, cosφ= 1

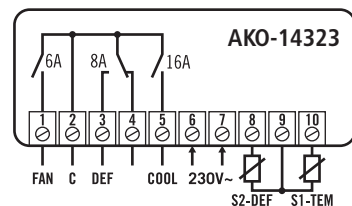
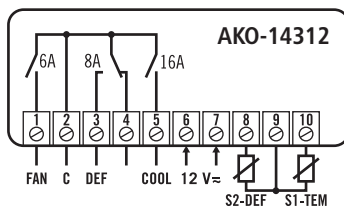

Reference	Description	Family	Pack
AKO-14312	12V~, 3 relays (one 16A), 1 NTC probe included	1510	12 Units
AKO-14320	120V~, 3 relays (one 16A), 1 NTC probe included	1510	12 Units
AKO-14323	230V~, 3 relays (one 16A), 1 NTC probe included	1510	12 Units

Temperature controllers Range from -50°C to +99°C, 3 relays, modular



Relay for compressor, fans and defrost.

Defrost by electric heat, air or hot gas bypass, programmable by regulating the compressor, resistances (or hot gas bypass) and fans.
With a 2nd optional probe allowing defrost by temperature

Application: Industrial and commercial cold, displays, electric panels, etc.

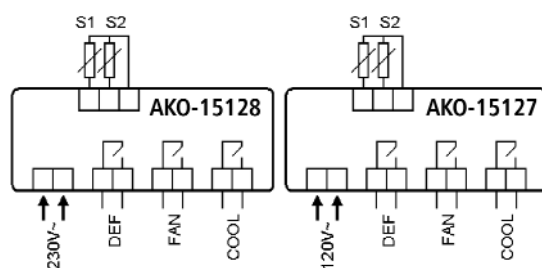

- Temperature range -50°C to +99°C
- Resolution 1°C
- Accuracy ±1°C
- NTC probe
- Compressor relay SPST 20A, 250V, cosφ = 1
- Fan relay SPST 6A, 250V, cosφ = 1
- Defrost relay SPDT 8A, 250V, cosφ = 1

Reference	Description	Family	Pack
AKO-14530	Control module, with 1 NTC probe included	1510	12 Units
AKO-15121	1.0 m cable for interconnection	1590	10 Units
AKO-15122	2.0 m cable for interconnection	1590	10 Units
AKO-15123	0.3 m cable for interconnection	1590	10 Units
AKO-15127	Power supply auxiliary module 120V~	1510	10 Units
AKO-15128	Power supply auxiliary module 230V~	1510	10 Units

Temperature controllers Range from -50°C to +99°C, 4 relay, panel mounting



Compressor, fan, defrost and alarm relays.

Defrost by electric heat, air or hot gas bypass, programmable by regulating the compressor, resistances (or hot gas bypass) and fans. With a 2nd optional probe, it enables defrost by temperature. Additional relay for indicating alarms. Possible password for entering programming, indication in °C or °F programme-selectable and probe calibration. Input for independent temperature probe. Digital input for door contact.

Application: Industrial and commercial cold, displays, electrical panels, etc.

- Temperature range -50°C to +99°C
- Display 3 Digits (°C/°F)
- Resolution 0.1°C
- Accuracy ±1°C
- NTC probe
- Panel cut-out dimensions 70.5 x 28.5 mm
- Front part dimensions 75.8 x 33.8 mm
- Depth 61 mm
- Compressor relay SPST 16A, 250V, cosφ= 1
- Fan relay SPST 6A, 250V, cosφ = 1
- Defrost relay SPDT 8A, 250V, cosφ = 1
- Alarm relay SPST 6A, 250V, cosφ= 1

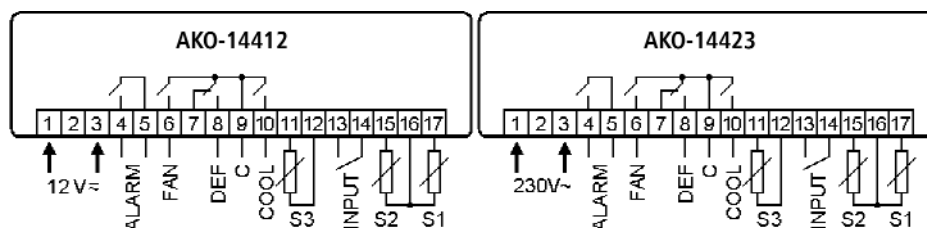

Reference	Description	Family	Pack
AKO-14412	12V~, 4 relays (one 16A), 1 NTC probe included	1510	12 Units
AKO-14423	230V~, 4 relays (one 16A), 1 NTC probe included	1510	12 Units

Thermometers

Range from -50°C to $+150^{\circ}\text{C}$, wall mounting



NTC or PTC probe programme-selectable.

Temperature display in cold and heat applications. Allows probe calibration, display in $^{\circ}\text{C}$ or $^{\circ}\text{F}$ and password to enter programming. Fixing holes adapted to universal embedding box.

Application: Industrial and commercial cold, cold rooms, industrial warehouses, etc.

- With NTC probe, temperature range from -50.0°C to $+99.9^{\circ}\text{C}$
- With PTC probe, temperature range from -50.0°C to $+150^{\circ}\text{C}$
- Display 3 Digits ($^{\circ}\text{C}/^{\circ}\text{F}$)
- Resolution 0.1°C
- Accuracy $\pm 1^{\circ}\text{C}$
- Box dimensions 171 x 94 x 42 mm
- Power supply 230V~ $\pm 10\%$, 50/60 Hz

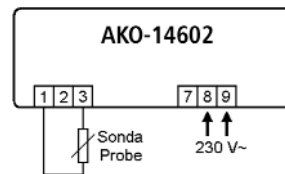

Reference	Description	Family	Pack
AKO-14602	Thermometer 230V~, 1 NTC probe included	1510	10 Units

Temperature controllers

Range from -50°C to $+150^{\circ}\text{C}$, 1 relay, wall mounting



Programmable for cold and heat

NTC or PTC probe programme-selectable. Display and control with decimal point. Wall mounting. Fixing holes adapted to universal embedding box. Parameter protection by password. Indication in $^{\circ}\text{C}$ or $^{\circ}\text{F}$

Application: Industrial and commercial cold, cold rooms stores, incubators, industrial warehouses, etc.

- With NTC probe, temperature range from -50.0°C to $+99.9^{\circ}\text{C}$
- With PTC probe, temperature range from -50.0°C to $+150^{\circ}\text{C}$
- Display 3 Digits ($^{\circ}\text{C}/^{\circ}\text{F}$)
- Resolution 0.1°C
- Accuracy $\pm 1^{\circ}\text{C}$
- Box dimensions 171 x 94 x 42 mm
- Control relay SPST 16A, 250V, $\cos\varphi=1$
- Power supply 230V~ $\pm 10\%$, 50/60 Hz

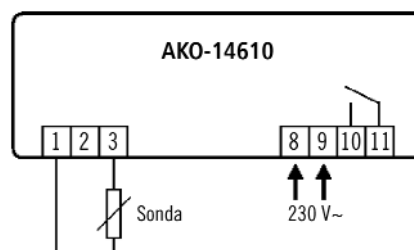

Reference	Description	Family	Pack
AKO-14610	Controller 230V~, 1 SPST relay, 1 NTC probe included	1510	10 Units
AKO-14612	Controller 120V~, 1 SPST relay, 1 NTC probe included	1510	10 Units

Temperature controllers Range from -50°C to +99°C, 3 relays, wall mounting



Defrost by electric heat, air or hot gas bypass.

Programmable defrost by regulating the compressor, resistances (or hot gas bypass) and fans. With a 2nd optional probe, it enables defrost by temperature. Password enabled for entering the programming. Indication in °C or °F selectable by programme and probe calibration.

Application: Industrial and commercial cold, cold room stores, etc.

- Temperature range -50°C to +99.9°C
- Display 3 Digits (°C/°F)
- Resolution 0.1 °C
- Accuracy ±1 °C
- NTC probe
- Box dimensions 171 x 94 x 42 mm
- Digital input for door contact.
- Compressor relay SPST 16A, 250V, cosφ = 1
- Fan relay SPST 6A, 250V, cosφ = 1
- Defrost relay SPDT 8A, 250V, cosφ = 1
- Power supply 230V~ ±10%, 50/60 Hz

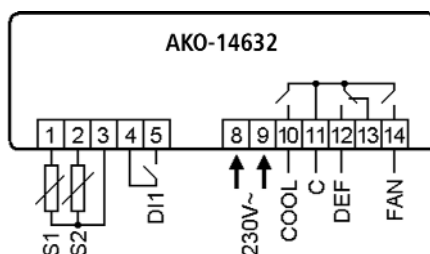

Reference	Description	Family	Pack
AKO-14632	Controller 230V~, 3 SPST relay, 1 NTC probe included	1510	10 Units

Temperature controllers Range from -50°C to +99°C, 4 relays, wall mounting



Configurable auxiliary relay

Defrost by electric heat, air or hot gas bypass, programmable by regulating the compressor, resistances (or hot gas bypass) and fans. With a 2nd optional probe, it enables defrost by temperature. Auxiliary relay configurable for indicating alarms, defrost 2nd evaporator or solenoid control. Possible stop for pump down. Input for independent temperature probe or defrost control in 2nd evaporator. Digital input for door contact.

Application: Industrial and commercial cold, cold room stores, etc.

- Temperature range -50°C to +99.9°C
- Display 3 Digits (°C/°F)
- Resolution 0.1°C
- Accuracy ±1 °C
- NTC probe
- Box dimensions 171 x 94 x 42 mm
- Compressor relay SPST 16A, 250V, cosφ = 1
- Fan relay SPST 6A, 250V, cosφ = 1
- Defrost relay SPDT 8A, 250V, cosφ = 1
- Auxiliary relay SPST 6A, 250V, cosφ = 1
- Power supply 230V~ ±10%, 50/60 Hz

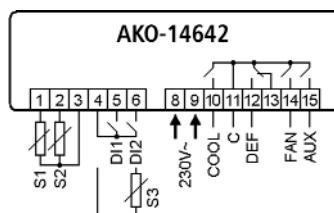

Reference	Description	Family	Pack
AKO-14642	Controller 230V~, 4 relays, 1 NTC probe included	1510	10 Units

Temperature controllers Range from -50°C to +99°C, 1 relay, DIN rail mounting



Defrost by compressor shutdown.

3 keys: Up, Down, Set. Possible password for entering programming, indication in °C or °F programme-selectable and probe calibration. Input for independent temperature probe. Digital input for door contact.

Application: Industrial and commercial cold, displays, electric panels, etc.

- Temperature range -50°C to +99°C
- Display 3 Digits (°C/°F)
- Resolution 0.1 °C
- Accuracy ±1 °C
- NTC probe
- Power supply 230V~ ±10%, 50/60Hz
- Box dimensions 70 x 90 x 58 mm (4 DIN modules)
- Front part dimensions 42.2 x 66.2 mm
- Compressor relay SPST 16A, 250V, $\cos\phi = 1$

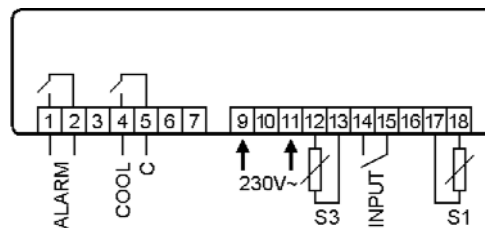

Reference	Description	Family	Pack
AKO-12123 / AKOTIM-21TE	230V~, 1 relay SPST 16A, 1 NTC probe included	1520	6 Units

Temperature controllers Range from -50°C to +99°C, 2 relays, DIN rail mounting



Compressor relay and R2 (defrost or fans).

3 keys: Up, Down, Set. Defrost by electric heat or air. The 2nd relay allows one of the following options to be regulated:
 - Defrost by electric heat
 - Defrost by hot gas bypass
 - Defrost by air

With a 2nd optional probe, it enables defrost by temperature. Possible password for entering programming, indication in °C or °F programme-selectable and probe calibration. Input for independent temperature probe. Digital input for door contact.

Application: Industrial and commercial cold, displays, electric panels, etc.

- Temperature range -50°C to +99°C
- Display 3 Digits (°C/°F)
- Resolution 0.1°C
- Accuracy ±1 °C
- NTC probe
- Power supply 230V~ ±10%, 50/60Hz
- Box dimensions 70 x 90 x 58 mm (4 DIN modules)
- Front part dimensions 42.2 x 66.2 mm
- Compressor relay SPST 16A, 250V, $\cos\phi = 1$
- Relay R2 SPDT 8A, 250V, $\cos\phi = 1$

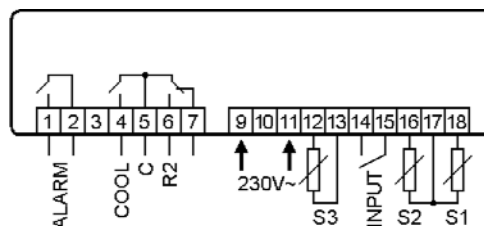

Reference	Description	Family	Pack
AKO-12223 / AKOTIM-22TE	230V~, 2 relays (one 16A), 1 NTC probe included	1520	6 Units

Temperature controllers Range from -50°C to +99°C, 3 relays, DIN rail mounting



Relay for compressor, fans and defrost.

3 keys: Up, Down, Set. Defrost by electric heat, air or hot gas bypass, programmable by regulating the compressor, resistances (or hot gas bypass) and fans. With a 2nd optional probe, it enables defrost by temperature. Possible password for entering programming, indication in °C or °F programme-selectable and probe calibration. Input for independent temperature probe. Digital input for door contact.

Application: Industrial and commercial cold, displays, electric panels, etc.

- Temperature range -50°C to +99°C
- Display 3 Digits (°C/°F)
- Resolution 0.1°C
- Accuracy ±1°C
- NTC probe
- Power supply 230V ~ ±10%, 50/60Hz
- Box dimensions 70 x 90 x 58 mm (4 DIN modules)
- Front part dimensions 42.2 x 66.2 mm
- Compressor relay SPST 16A, 250V, cosφ= 1
- Fan relay SPST 6A, 250V, cosφ= 1
- Defrost relay SPDT 8A, 250V, cosφ= 1

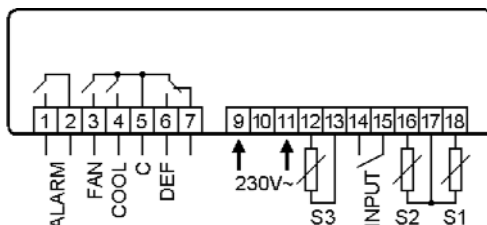

Reference	Description	Family	Pack
AKO-12323 / AKOTIM-23TE	230V~, 3 relays (one 16A), 1 NTC probe included	1520	6 Units

Temperature controllers Range from -50°C to +99°C, 4 relays, DIN rail mounting



Relay for compressor, fans, defrost and alarm.

3 keys: Up, Down, Set. Defrost by electric heat, air or hot gas bypass, programmable by regulating the compressor, resistances (or hot gas bypass) and fans. Defrost start triggered by clock in real time. With a 2nd optional probe, it enables defrost by temperature. Additional relay for indicating alarms. Possible password for entering programming, indication in °C or °F programme-selectable and probe calibration. Input for independent temperature probe. Digital input for door contact.

Application: Industrial and commercial cold, displays, electric panels, etc.

- Temperature range -50°C to +99°C
- Display 3 Digits (°C/°F)
- Resolution 0.1°C
- Accuracy ±1 °C
- NTC probe
- Power supply 230V~ ±10%, 50/60Hz
- Box dimensions 70 x 90 x 58 mm (4 DIN modules)
- Front part dimensions 42.2 x 66.2 mm
- Compressor relay SPST 16A, 250V, cosφ= 1
- Fan relay SPST 6A, 250V, cosφ= 1
- Defrost relay SPDT 8A, 250V, cosφ= 1
- Alarm relay SPST 6A, 250V, cosφ= 1

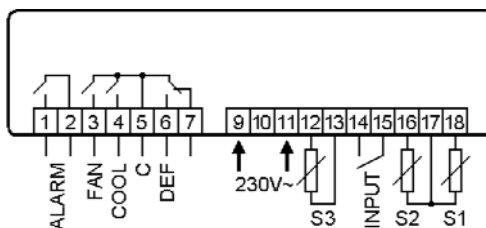

Reference	Description	Family	Pack
AKO-12423 / AKOTIM-23ARTE	230V~, 4 relays (one 16A), 1 NTC probe included	1520	6 Units

Large frontal temperature controllers 2 relays, panel mounting



Compressor and light relay.

6 keys: Up, Down, Set, Escape, Light and ON/OFF. Pushbutton to turn the unit on and off and light switch. Defrost by compressor shut-down. Continuous cycle is possible. Password enabled for entering programming, programme-selectable indication in °C or °F. Digital input configurable for door contact, severe alarm, remote defrost, change in set-point temperature

Application: Industrial and commercial cold, displays, electric panels, etc.

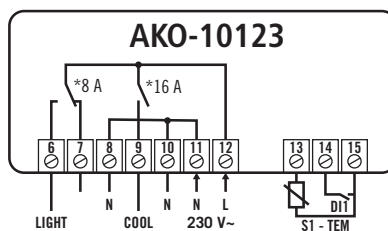

- Temperature range -50°C to +99°C
- Display 3 Digits (°C/°F)
- Resolution 0.1°C
- Accuracy ±1 °C
- NTC probe
- Panel cut-out dimensions 150 x 31 mm
- Box dimensions 149 x 30 x 57.7 mm
- Trim 179.9 x 37.9 mm
- Compressor relay SPST 16A, 250V, cosφ=1
- Light relay SPDT 8A, 250V, cosφ=1
- Power supply 230V~ ±10%, 50/60Hz

Reference	Description	Family	Pack
AKO-10123	Controller 2 relays, 230V~, 1 NTC probe included	1510	10 Units

Large frontal temperature controllers 3 relays, panel mounting



Compressor relay, (defrost or fans) and light.

6 keys: Up, Down, Set, Escape, Light and ON/OFF. Pushbutton to turn the unit on and off and light switch. Defrost by electric heat or by air and possible continuous cycle. Password enabled for entering programming, programme-selectable indication in °C or °F. Digital input configurable for door contact, severe alarm, remote defrost, change in set-point temperature

Application: Industrial and commercial cold, displays, electric panels, etc.

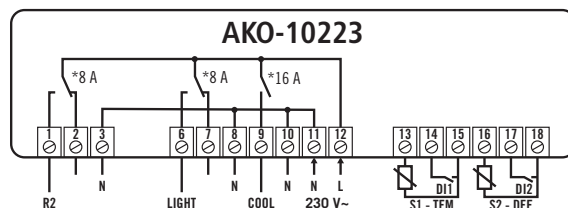

- Temperature range -50°C to +99°C
- Display 3 Digits (°C/°F)
- Resolution 0.1°C
- Accuracy ±1 °C
- NTC probe
- Panel cut-out dimensions 150 x 31 mm
- Box dimensions 149 x 30 x 57.7 mm
- Trim 179.9 x 37.9 mm
- Compressor relay SPST 16A, 250V, cosφ=1
- Relay R2 SPDT 8A, 250V, cosφ=1
- Light relay SPDT 8A, 250V, cosφ=1
- Power supply 230V~ ±10%, 50/60Hz

Reference	Description	Family	Pack
AKO-10223	Controller 3 relays, 230V~, 1 NTC probe included	1510	10 Units

Large frontal temperature controllers 4 relays, panel mounting



Compressor relay, defrost, fans and light.

6 keys: Up, Down, Set, Escape, Light and ON/OFF. Pushbutton to turn the unit on and off and light switch. Defrost by electric heat or by air and possible continuous cycle. Password enabled for entering programming, programme-selectable indication in °C or °F. Digital input configurable for door contact, severe alarm, remote defrost, adjustment temperature change.

Application: Industrial and commercial cold, displays, electric panels, etc.

- Temperature range -50°C to +99°C
- Display 3 Digits (°C/°F)
- Resolution 0.1°C
- Accuracy ±1 °C
- NTC probe
- Panel cut-out dimensions 150 x 31 mm
- Box dimensions 149 x 30 x 57.7 mm
- Trim 179.9 x 37.9 mm
- Compressor relay SPST 16A, 250V, cosφ=1
- Fan relays SPST 8A, 250V, cosφ=1
- Defrost relay SPDT 8A, 250V, cosφ=1
- Light relay SPDT 8A, 250V, cosφ=1
- Power supply 230V~ ±10%, 50/60Hz

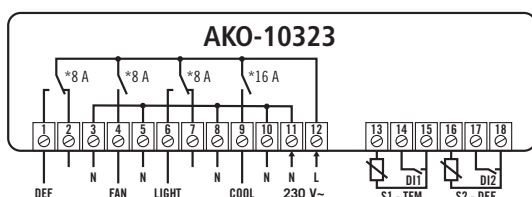

Reference	Description	Family	Pack
AKO-10323	Controller 4 relays, 230V~, 1 NTC probe included	1510	10 Units

Thermometers Range from -50°C to +70°C, panel mounting



AKO-80032



AKO-80025

Battery thermometers.

Temperature display in cold and heat applications.

Application: Industrial and commercial cold, displays.

- Temperature range from -50°C to +70°C
- Display LCD
- Resolution 0.1°C
- Accuracy ±1°C
- Power supply: 1.5V battery (G10)
- Size of the AKO-80025 48 x 28.6 x 14 mm.
- Size of the AKO-80032 85.2 x 29.2 x 14.8 mm.

Reference	Description	Family	Pack
AKO-80025	1.5V Batteries (G10), probe 3 m	1510	25 Units
AKO-80032	Solar power supply + 1.5V batteries (G10), probe 3 m	1510	25 Units

Temperature controllers Range from -99.9°C to +1370°C, 48 x 48 format



Input for Pt100 probe, J and K thermocouple.

ON/OFF Control. Programmable for cold and heat. With the 2 outputs, the controller can be used to work as a stage plus alarm.

Application: Ovens, electrical panels, industrial installations, etc.

- Temperature range with Pt100 probe -99.9°C to +850.0°C
- Temperature range with J thermocouple -99.9°C to +800.0°C
- Temperature range with K thermocouple -99.9°C to +1370°C
- Resolution 0.1 °C
- Accuracy ±1 °C

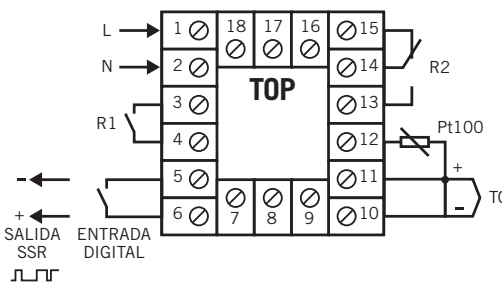

- Display 4 Digits (°C/°F)
- Output control SSR 12Vdc, max. 10mA
- Front part dimensions 48 x 48 mm
- Panel cut-out dimensions 45 x 45 mm
- Depth 119 mm
- Relay R1 SPST 6 A, 250V, cosφ= 1
- Relay R2 SPDT 5 A, 250V, cosφ= 1

Reference	Description	Family	Pack
AKO-15440	ON/OFF controller with power supply from 20 to 48V~	1535	1 Unit
AKO-15490	ON/OFF controller with power supply from 100 to 240V~	1535	1 Unit

PID controller, 48 x 48 format Range from -99.9°C to +1370°C



Input for Pt100 probe, Thermocouple J and K, 4-20mA

Programmable for cold and heat. Controller PID or ON/OFF programme-selectable. Self-tuning function. Probe input configurable as Pt100, thermocouple J and K, 4-20mA. With the 2 outputs, the controller can be used to work as a stage plus alarm. Digital input configurable for SetPoint change or start-stop of the unit.

Application: Ovens, electrical panels, industrial installations, etc.

- Temperature range with Pt100 probe -99.9°C to +850.0°C
- Temperature range with J thermocouple -99.9°C to +800.0°C
- Temperature range with K thermocouple -99.9°C to +1370°C
- Temperature range with 4-20mA -999°C to +2500°C
- Resolution 0.1°C
- Accuracy ±1 °C

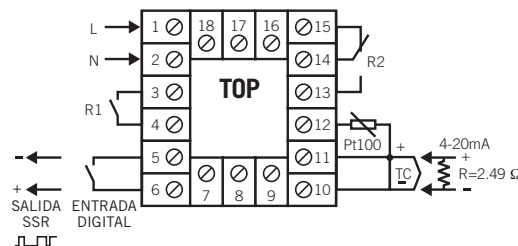

- Display 4 Digits (°C/°F)
- Output control SSR 12Vdc, max. 10mA
- Front part dimensions 48 x 48 mm
- Panel cut-out dimensions 45 x 45 mm
- Depth 119 mm
- Relay R1 SPST 6A, 250V, cosφ=1
- Relay R2 SPDT 5A, 250V, cosφ=1

Reference	Description	Family	Pack
AKO-15400	Controller with power supply from 20 to 48V~	1535	1 Unit
AKO-15450	Controller with power supply from 100 to 240V~	1535	1 Unit

PID controller, 48 x 48 format Range from -99.9°C to +1370°C, 4-20mA/0-10V output



With 4-20mA/0-10V output.

Programmable for cold and heat. Controller PID or ON/OFF programme-selectable. Self-tuning function. Probe input configurable as Pt100, thermocouple J and K, 4-20mA. With the 2 outputs, the controller can be used to work as a stage plus alarm. With the 4-20mA/0-10V output option, we have an analogue output to govern a valve or to resend the signal to a variator or PLC. With the RS-485 communication option, the unit can be connected to a network working with ModBus protocol.

Application: Ovens, electrical panels, industrial installations, etc.

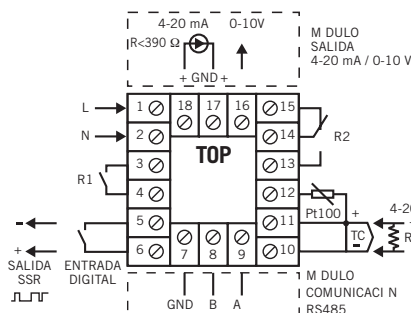

- Temperature range with Pt100 probe -99.9°C to +850.0°C
- Temperature range with J thermocouple -99.9°C to +800.0°C
- Temperature range with K thermocouple -99.9°C to +1370°C
- Temperature range with 4-20mA -99.9°C to +2500°C
- Resolution 0.1 °C
- Accuracy ±1 °C
- Display 4 Digits (°C/°F)
- Output control SSR 12Vdc, maximum 10mA
- Front part dimensions 48 x 48 mm
- Panel cut-out dimensions 45 x 45 mm
- Depth 119 mm
- Relay R1 SPST 6 A, 250V, cosφ= 1
- Relay R2 SPDT 5 A, 250V, cosφ= 1

Reference	Description	Family	Pack
AKO-15430	20 to 48V~, with 4-20mA output	1535	1 Unit *
AKO-15437	20 to 48V~, with 4-20mA output and communication	1535	1 Unit *
AKO-15480	100 to 240V~, with 4-20mA output	1535	1 Unit
AKO-15487	100 to 240V~, with 4-20mA output and communication	1535	1 Unit

* Available on request

PID controller, 48 x 48 format Range from -99.9°C to +1370°C, 3 relays



With additional relay output.

Programmable for cold and heat. Controller PID or ON/OFF programme-selectable. Self-tuning function. Probe input configurable as Pt100, thermocouple J and K, 4-20mA. Digital input configurable for SetPoint change or start-stop of the unit. With the 3 outputs, the controller can operate as a two stage, a neutral zone, with alarm signalling. With the 4-20mA/0-10V output option, we have an analogue output to govern a valve or to resend the signal to a variator or PLC. With the option of an input for current transformer (C.T.) the breakage of the heating resistance can be detected.

Application: Ovens, electrical panels, industrial installations, etc.

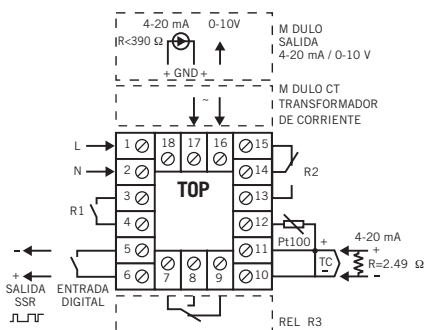

- Temperature range with Pt100 probe -99.9°C to +850.0°C
- Temperature range with J thermocouple -99.9°C to +800.0°C
- Temperature range with K thermocouple -99.9°C to +1370°C
- Temperature range with 4-20mA -99.9°C to +2500°C
- Resolution 0.1 °C
- Accuracy ±1 °C
- Display 4 Digits (°C/°F)
- Output control SSR 12Vdc, maximum 10mA
- Front part dimensions 48 x 48 mm
- Panel cut-out dimensions 45 x 45 mm
- Depth 119 mm
- Relay R1 SPST 6 A, 250V, cosφ= 1
- Relay R2 SPDT 5A, 250V, cosφ= 1
- Relay R3 SPST 5 A, 250V, cosφ= 1

Reference	Description	Family	Pack
AKO-15410	20 to 48V~, relay 3 SPDT 5A	1535	1 Unit *
AKO-15413	20 to 48V~, relay 3 SPDT 5A, with 4-20mA output	1535	1 Unit *
AKO-15415	20 to 48V~, relay 3 SPDT 5A, with input for C.T.	1535	1 Unit *
AKO-15460	100 to 240V~, relay 3 SPDT 5A	1535	1 Unit
AKO-15463	100 to 240V~, relay 3 SPDT 5A, with 4-20mA output	1535	1 Unit
AKO-15465	100 to 240V~, relay 3 SPDT 5A, with input for C.T.	1535	1 Unit *
AKO-80033	Current transformer (CT) 25A/0.05A	1590	25 Units

* Available on request

PID controller, 48 x 48 format with RS485 communication

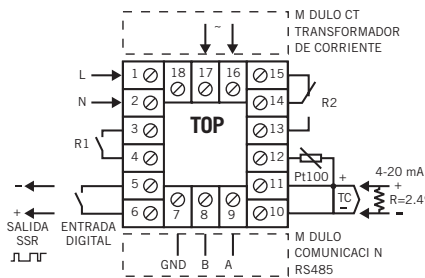

Communication and input for current transformer

Programmable for cold and heat. Controller PID or ON/OFF programme-selectable. Self-tuning function. Probe input configurable as Pt100, thermocouple J and K, 4-20mA. With the 2 outputs, the controller can be used to work as a stage plus alarm. With the option of an input for current transformer (C.T.) the breakage of the heating resistance can be detected. With the RS-485 communication option, the unit can be connected to a network working with ModBus protocol.

Application: Ovens, electrical panels, industrial installations, etc.

- Temperature range with Pt100 probe -99.9°C to +850.0°C
- Temperature range with J thermocouple -99.9°C to +800.0°C
- Temperature range with K thermocouple -99.9°C to +1370°C
- Temperature range with 4-20mA -999°C to +2500°C
- Resolution 0.1°C / Accuracy ±1°C
- Display 4 Digits (°C/°F)
- Output control SSR 12Vdc, maximum 10mA
- Front part dimensions 48 x 48 mm
- Panel cut-out dimensions 45 x 45 mm
- Depth 119 mm
- Relay R1 SPST 6 A, 250V, cosφ=1
- Relay R2 SPDT 5 A, 250V, cosφ=1

Reference	Description	Family	Pack
AKO-15401	20 to 48V~, with input for C.T.	1535	1 Unit *
AKO-15402	20 to 48V~, with communication	1535	1 Unit *
AKO-15403	20 to 48V~, with input for C.T. and communication	1535	1 Unit *
AKO-15451	100 to 240V~, with input for C.T.	1535	1 Unit *
AKO-15452	100 to 240V~, with communication	1535	1 Unit
AKO-15453	100 to 240V~, with input for C.T. and communication	1535	1 Unit *
AKO-80033	Intensity transformer (CT) 25A/0.05A	1590	25 Units

* Available on request

Input controllers 4/20mA Range from -999 to +999. 2 relays, panel mounting



2 control relays.

Programmable for direct and inverse operation. With 2 relay outputs, the controller can be used to work as 2 independent stages, 2 related stages, neutral zone and 1 stage plus alarm. It has 1 digital input for remote change of the SetPoint

Application: Fryers, electric panels, industrial installations, sewage treatment plants, etc.

- Measurement range -999 to +999
- 3-digit display
- Resolution 0.1
- Accuracy ±1 %
- Probe type 4-20mA
- Panel cut-out dimensions 70.5 x 28.5 mm
- Front part dimensions 75.8 x 33.8 mm
- Depth 61 mm
- Control relays SPDT 8A, 250V, cosφ= 1

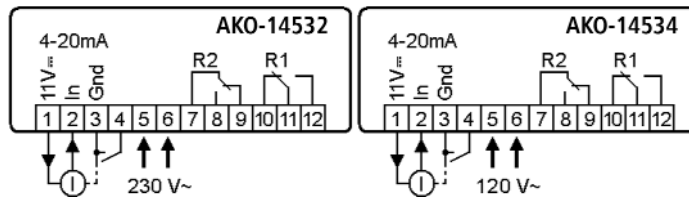

Reference	Description	Family	Pack
AKO-14532	230V~, 2 relays SPDT 8A	1510	12 Units
AKO-14534	120V~, 2 relays SPDT 8A	1510	12 Units
AKO-80013	Wall humidity probe, 10 to 95%, -5/50°C, output 4-20mA	1590	1 Unit
AKO-80040	Tubular humidity probe, 5 to 95%, -10/70°C, output 4-20mA	1590	1 Unit

Temperature controllers Range from -99.9°C to +1000°C, 2 relays, panel mounting



Input for Pt100, NTC, PTC probes, J and K thermocouple.

Programmable for cold and heat.

With the 2 relay outputs, the controller can be used to work as 2 independent stages, 2 related stages, neutral zone and one stage plus alarm.

Digital input for SetPoint change.

Application: Ovens, electric panels, industrial installations, incubators, etc.

- Temperature range with Pt100 probe -100°C to +440°C
- Temperature range with NTC probe -50°C to +100°C
- Temperature range with PTC probe -50°C to +150°C
- Temperature range with J thermocouple 0°C to +600°C
- Temperature range with K thermocouple 0°C to +1000°C
- Resolution 0.1°C (1°C for J, K thermocouples)
- Accuracy ±1 °C (±2°C for J, K thermocouples)
- Display 3 Digits (°C/°F)
- Panel cut-out dimensions 70.5 x 33.8 mm
- Front part dimensions 75.8 x 33.8 mm
- Depth 61 mm
- Control relays 2 SPDT 8A, 250V, $\cos\phi=1$

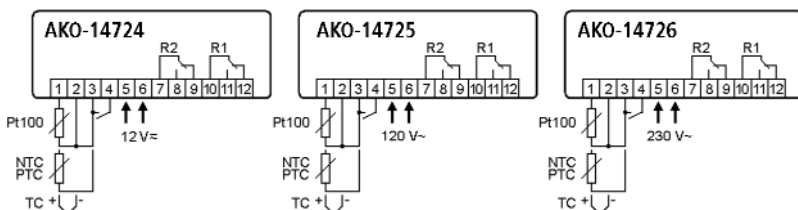

Reference	Description	Family	Pack
AKO-14724	12V~, for panel cut-out 70.5 x 28.5 mm	1530	12 Units
AKO-14725	120V~, for panel cut-out 70.5 x 28.5 mm	1530	12 Units
AKO-14726	230V~, for panel cut-out 70.5 x 28.5 mm	1530	12 Units

Temperature controllers Range from -50.0°C to +600°C, 2 relays, panel mounting



Pt100 probe input.

Programmable for cold and heat.

With the 2 relay outputs, the controller can be used to work as 2 independent stages or neutral zone

Application: Ovens, electrical panels, industrial installations, etc.

- Temperature range -50°C to +600°C
- Display 3 Digits (°C/°F)
- Resolution 1°C
- Accuracy ±0.5 °C
- Probe type Pt100
- Panel cut-out dimensions 70.5 x 28.5 mm
- Front part dimensions 75.8 x 33.8 mm
- Depth 61 mm
- Control relays 2 SPDT 8A, 250V, $\cos\phi=1$
- Power supply 12V± ±15%, 50/60Hz

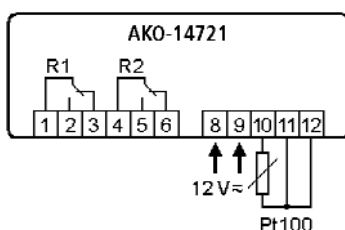

Reference	Description	Family	Pack
AKO-14721	12V~, for Pt-100 probe no included	1530	12 Units

Temperature controllers

Range from -99.9°C to +1000°C, 2 relays, DIN rail mounting



CE US

Input for Pt100, NTC, PTC probes, J and K thermocouple.

With the 2 relay outputs, the controller can be used to work as 2 independent stages, 2 related stages, neutral zone and one stage plus alarm.

Digital input for SetPoint change.

Application: Ovens, electric panels, industrial installations, incubators, etc.

- Temperature range with Pt100 probe -100°C to +440°C
- Temperature range with NTC probe -50°C to +100°C
- Temperature range with PTC probe -50°C to +100°C

- Temperature range with J thermocouple 0°C to +600°C
- Temperature range with K thermocouple 0°C to +1000°C
- Display 3 Digits (°C/°F)
- Resolution 0.1°C (1°C for J, K thermocouples)
- Accuracy ±1 °C (±2°C for J, K thermocouples)
- Probe type Pt100, NTC, PTC, J and K thermocouples)
- Box dimensions 70 x 90 x 58 mm (4 DIN modules)
- Front part dimensions 42.2 x 66.2 mm
- Control relays 2 SPDT 8A, 250V, cosφ=1

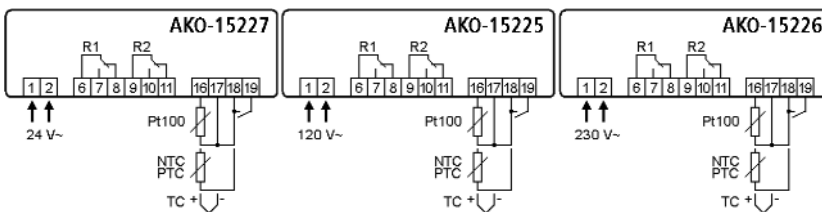

Reference	Description	Family	Pack
AKO-15227	24V~, for DIN rail 4 modules, 70 x 58 x 90 mm	1530	6 Units
AKO-15225	120V~, for DIN rail 4 modules, 70 x 58 x 90 mm	1530	6 Units
AKO-15226	230V~, for DIN rail 4 modules, 70 x 58 x 90 mm	1530	6 Units

Solar energy controllers

Differential thermostat 2 relays, wall mounting



Pump controls, support resistance or air-thermal.

Input for 2 probes. Probe 1 configurable as NTC or PTC, probe 2 NTC. De-icing function. Second relay programmable as air-thermal regulating function to limit the temperature in the solar panel or thermostat function for the support resistance in the accumulator. Parameter protection by password. Test pushbuttons. Low consumption. Fixing holes adapted to universal embedding box.

Application: Thermal solar energy installations

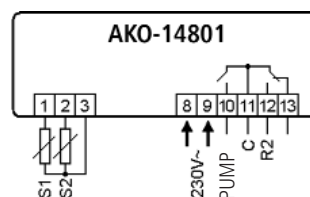

- With NTC probe, temperature range from -50.0°C to +99.9°C
- With PTC probe, temperature range from -50.0°C to +150°C
- Display 3 Digits (°C/°F)
- Resolution 0.1°C
- Accuracy ±1 °C
- Box dimensions 171 x 94 x 42 mm
- Pump relay SPST 16A, 250V, cosφ= 1
- Relay R2 SPDT 8A, 250V, cosφ= 1
- Power supply 230V~ ±10%, 50/60 Hz

Reference	Description	Family	Pack
AKO-14801	Controller 230V~, 2 relays, 1 NTC probe included	1530	10 Units

Solar energy controllers Panel differential thermostat



Panel format for integration in panel.

Input for 2 NTC probes. De-icing function. Pump stop for excessive temperature in probe 2. Low consumption.

Application: Solar thermal energy installations

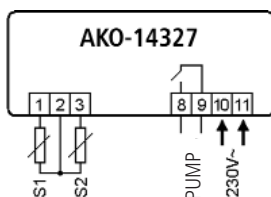

- Temperature range from -50.0°C to +99.9°C
- Resolution 1°C
- Accuracy ±1 °C
- Panel cut-out dimensions 70.5 x 28.5 mm
- Front part dimensions 75.8 x 33.8 mm
- Depth 61 mm
- Pump relay SPST 16A, 250V, cosφ= 1
- Power supply 230V~ ±10%, 50/60 Hz

Reference	Description	Family	Pack
AKO-14327	Controller 230V~, 1 relay, 1 NTC probe included	1530	10 Units

Solar energy controllers Differential thermostat, DIN rail mounting (4 modules)



DIN rail format for panel integration.

Input for 2 NTC probes. De-icing function. Pump stop for excessive temperature in probe 2. Low consumption.

Application: Thermal solar energy installations

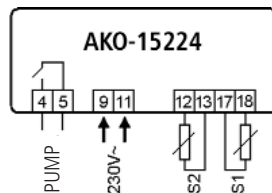

- Temperature range -50°C to +99°C
- Display 3 Digits (°C/°F)
- Resolution 0.1°C
- Accuracy ±1 °C
- NTC probe
- Box dimensions 70 x 90 x 58 mm (4 DIN modules)
- Front part dimensions 42.2 x 66.2 mm
- Pump relay SPST 16A, 250V, cosφ= 1
- Power supply 230V~ ±10%,50/60 Hz

Reference	Description	Family	Pack
AKO-15224	Controller 230V~, 1 relay, 1 NTC probe included	1530	6 Units

Temperature controllers 2 relays, up to 2 probes, panel mounting



Multifunction.

The two probe inputs may be linked with the relay outputs for the functions of thermometer and thermostat in cold and heat applications, as a differential control of the two probes, double thermostat, two stages, neutral zone, etc. The configuration of the menus means that certain parameters may or may not be adjusted by the user, so that they might exclusively have the information and adjustment that the use of the machine requires. It is possible to modify the functions of the keys on the front and the temperature display. The configuration may be blocked by password.

Application: Solar energy, electric panels, industrial installations, etc

- Temperature range -50°C to $+100^{\circ}\text{C}$
- Display 3 Digits ($^{\circ}\text{C}/^{\circ}\text{F}$)
- Resolution 0.1°C
- Accuracy $\pm 1^{\circ}\text{C}$
- Type of NTC probe (1 included)
- Panel cut-out dimensions $70.5 \times 28.5 \text{ mm}$
- Front part dimensions $75.8 \times 33.8 \text{ mm}$
- Depth 61 mm
- Control relay R1 1 SPST 16A, 250V, $\cos\varphi=1$
- Control relay R2 1 SPDT 8A, 250V, $\cos\varphi=1$

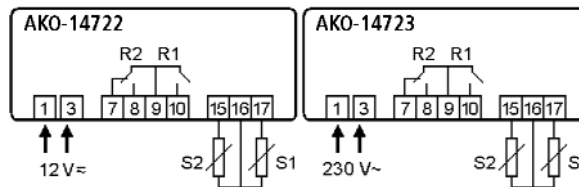

Reference	Description	Family	Pack
AKO-14722	12V~, for panel cut-out $70.5 \times 28.5 \text{ mm}$	1530	12 Units
AKO-14723	230V~, for panel cut-out $70.5 \times 28.5 \text{ mm}$	1530	12 Units

Temperature controllers 2 relays, up to 2 probes, DIN rail mounting



Multifunction

The two probe inputs may be linked with the relay outputs for the functions of thermometer and thermostat in cold and heat applications, as a differential control of the two probes, double thermostat, two stages, neutral zone, etc. The configuration of the menus means that certain parameters may or may not be adjusted by the user, so that they might exclusively have the information and adjustment that the use of the machine requires. It is possible to modify the functions of the keys on the front and the temperature display. The configuration may be blocked by password.

Application: Solar energy, electric panels, industrial installations, etc

- Temperature range -50°C to $+100^{\circ}\text{C}$
- Display 3 Digits ($^{\circ}\text{C}/^{\circ}\text{F}$)
- Resolution 0.1°C
- Accuracy $\pm 1^{\circ}\text{C}$
- Type of NTC probe (1 included)
- Box dimensions $70 \times 90 \times 58 \text{ mm}$ (4 DIN modules)
- Front part dimensions $42.2 \times 66.2 \text{ mm}$
- Control relay R1 1 SPST 16A, 250V, $\cos\varphi=1$
- Control relay R2 1 SPDT 8A, 250V, $\cos\varphi=1$
- Power supply $230\text{V} \sim \pm 10\%$, 50/60Hz

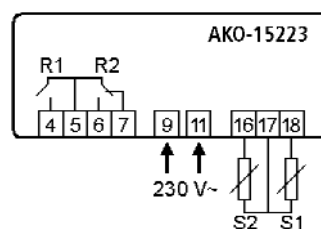

Reference	Description	Family	Pack
AKO-15223	230V~, for DIN rail	1530	6 Units

Modular controllers **AKOTIM** Range from -50°C to +99°C, 1 relay, panel mounting



Compressor control relay.

Used to regulate the temperature of cold generators and to display the information from the operation log on, the refrigeration time, the defrost time and the complete cycle. They store information on the maximum and minimum temperatures reached, in addition to other useful parameters to the HACCP. Programme-selectable indication in °C or °F. 2 inputs for control probe and independent temperature. Digital input for door contact. Defrost by compressor stop.

Application: Industrial and commercial cold, displays, electrical panels, etc.

- Temperature range -50°C to +99°C
- Display 3 Digits (°C/°F)
- Resolution 0.1°C
- Accuracy ±1 °C
- NTC probe
- Front part dimensions 75.8 x 33.8 mm
- Panel cut-out dimensions 70.5 x 28.5 mm
- Depth 61 mm
- Compressor relay SPST 16A, 250V, cosφ= 1
- Power supply 230V~ ±10%, 50/60 Hz

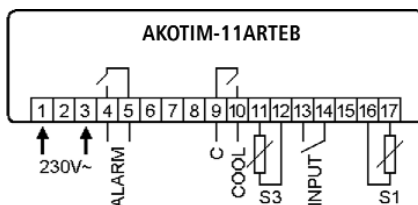

Reference	Alarm relay	Real time clock	Buzzer	Family	Pack
AKOTIM-11TE	-	-	-	1520	12 Units
AKOTIM-11ATE	Yes	-	-	1520	12 Units
AKOTIM-11ARTE	Yes	Yes	-	1520	12 Units
AKOTIM-11ARTEB	Yes	Yes	Yes	1520	12 Units

Modular controllers **AKOTIM** Range from -50°C to +99°C, 2 relays, panel mounting



Compressor relay and R2 (defrost or fans).

Used to regulate the temperature of cold generators and to display the information from the operation log on, the refrigeration time, the defrost time and the complete cycle. They store information on the maximum and minimum temperatures reached, in addition to other parameters of use to the HACCP

3 inputs for regulating probe, evaporator and independent temperature. Digital input for door contact. Defrost by electric heat or air. Programme-selectable indication in °C or °F.

Application: Industrial and commercial cold, displays, electrical panels, etc.

- Temperature range -50°C to +99°C
- Display 3 Digits (°C/°F)
- Resolution 0.1 °C
- Accuracy ±1 °C
- NTC probe
- Front part dimensions 75.8 x 33.8 mm
- Panel cut-out dimensions 70.5 x 28.5 mm
- Depth 61 mm
- Compressor relay SPST 16A, 250V, cosφ= 1
- Relay R2 SPDT 8A, 250V, cosφ= 1
- Power supply 230V~ ±10%, 50/60 Hz

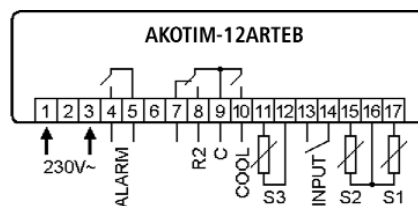

Reference	Alarm relay	Real time clock	Buzzer	Family	Pack
AKOTIM-12TE	-	-	-	1520	12 Units
AKOTIM-12ATE	Yes	-	-	1520	12 Units
AKOTIM-12ARTE	Yes	Yes	-	1520	12 Units
AKOTIM-12ARTEB	Yes	Yes	Yes	1520	12 Units

Modular controllers **AKOTIM** Range from -50°C to +99°C, 3 relays, panel mounting



Relay for compressor, fans and defrost.

Used to regulate the temperature of cold generators and to display the information from the operation log on, the refrigeration time, the defrost time and the complete cycle. They store information on the maximum and minimum temperatures reached, in addition to other useful parameters to the HACCP.

Programme-selectable indication in °C or °F. 2 inputs for control probe and independent temperature. Digital input for door contact. Defrost by electric heat, air or hot gas bypass

Application: Industrial and commercial cold, displays, electrical panels, etc.

- Temperature range -50°C to +99°C
- Display 3 Digits (°C/°F)
- Resolution 0.1°C
- Accuracy ±1 °C
- NTC probe
- Front part dimensions 75.8 x 33.8 mm
- Panel cut-out dimensions 70.5 x 28.5 mm
- Depth 61 mm
- Compressor relay SPST 16A, 250V, cosφ= 1
- Fan relays SPST 5A, 250V, cosφ= 1
- Defrost relay SPDT 8A, 250V, cosφ= 1
- Power supply 230V~ ±10%,50/60 Hz

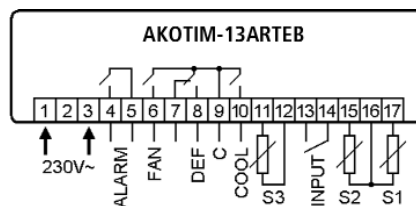

Reference	Alarm relay	Real time clock	Buzzer	Family	Pack
AKOTIM-13TE	-	-	-	1520	12 Units
AKOTIM-13ATE	Yes	-	-	1520	12 Units
AKOTIM-13ARTE	Yes	Yes	-	1520	12 Units
AKOTIM-13ARTEB	Yes	Yes	Yes	1520	12 Units

Modular controllers **AKOTIM** Range from -50°C to +99°C, 1 relay, DIN rail mounting



Compressor control relay

Used to regulate the temperature of cold generators and to display the information from the operation log on, the refrigeration time, the defrost time and the complete cycle. They store information on the maximum and minimum temperatures reached, in addition to other useful parameters to the HACCP Programme-selectable indication in °C or °F. 2 inputs for control probe and independent temperature. Digital input for door contact. Defrost by compressor stop.

Application: Industrial and commercial cold, displays, electrical panels, etc.

- Temperature range -50°C to +99°C
- Display 3 Digits (°C/°F)
- Resolution 0.1 °C
- Accuracy ±1 °C
- NTC probe
- Box dimensions 70 x 90 x 58 mm (4 DIN modules)
- Front part dimensions 42.2 x 66.2 mm
- Compressor relay SPST 16A, 250V, cosφ=1
- Power supply 230V~ ±10%,50/60 Hz

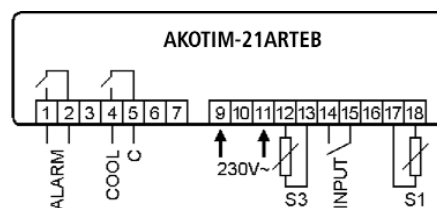

Reference	Alarm relay	Real time clock	Buzzer	Family	Pack
AKOTIM-21TE	-	-	-	1520	6 Units
AKOTIM-21ATE	Yes	-	-	1520	6 Units
AKOTIM-21ARTE	Yes	Yes	-	1520	6 Units
AKOTIM-21ARTEB	Yes	Yes	Yes	1520	6 Units

Modular controllers **AKOTIM** Range from -50°C to +99°C, 2 relays, DIN rail mounting



Compressor relay and R2 (defrost or fans).

Used to regulate the temperature of cold generators and to display the information from the operation log on, the refrigeration time, the defrost time and the complete cycle. They store information on the maximum and minimum temperatures reached, in addition to other useful parameters to the HACCP.

3 inputs for regulating probe, evaporator and independent temperature. Digital input for door contact. Defrost by electric heat or air. Programme-selectable indication in °C or °F.

Application: Industrial and commercial cold, displays, electrical panels, etc.

- Temperature range -50°C to +99°C
- Display 3 Digits (°C/°F)
- Resolution 0.1 °C
- Accuracy ±1 °C
- NTC probe
- Box dimensions 70 x 90 x 58 mm (4 DIN modules)
- Front part dimensions 42.2 x 66.2 mm
- Compressor relay SPST 16A, 250V, cosφ = 1
- Relay R2 SPDT 8A, 250V, cosφ = 1
- Power supply 230V~ ±10%, 50/60 Hz

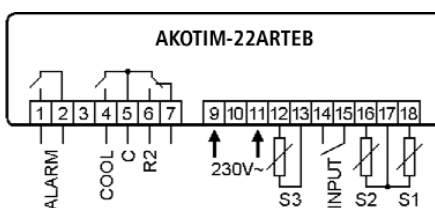

Reference	Alarm relay	Real time clock	Buzzer	Family	Pack
AKOTIM-22TE	-	-	-	1520	6 Units
AKOTIM-22ATE	Yes	-	-	1520	6 Units
AKOTIM-22ARTE	Yes	Yes	-	1520	6 Units
AKOTIM-22ARTEB	Yes	Yes	Yes	1520	6 Units

Modular controllers **AKOTIM** Range from -50°C to +99°C, 3 relays, DIN rail mounting



Relay for compressor, fans and defrost.

Used to regulate the temperature of cold generators and to display the information from the operation log on, the refrigeration time, the defrost time and the complete cycle. They store information on the maximum and minimum temperatures reached, in addition to other useful parameters to the HACCP.

Programme-selectable indication in °C or °F. 2 inputs for control probe and independent temperature. Digital input for door contact. Defrost by electric heat, air or hot gas bypass.

Application: Industrial and commercial cold, displays, electrical panels, etc.

- Temperature range -50°C to +99°C
- Display 3 Digits (°C/°F)
- Resolution 0.1 °C
- Accuracy ±1 °C
- NTC probe
- Box dimensions 70 x 90 x 58 mm (4 DIN modules)
- Front part dimensions 42.2 x 66.2 mm
- Compressor relay SPST 16A, 250V, cosφ = 1
- Fan relay SPST 5A, 250V, cosφ = 1
- Defrost relay SPDT 8A, 250V, cosφ = 1
- Power supply 230V~ ±10%, 50/60 Hz

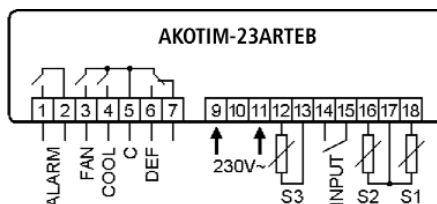

Reference	Alarm relay	Real time clock	Buzzer	Family	Pack
AKOTIM-23TE	-	-	-	1520	6 Units
AKOTIM-23ATE	Yes	-	-	1520	12 Units
AKOTIM-23ARTE	Yes	Yes	-	1520	12 Units
AKOTIM-23ARTEB	Yes	Yes	Yes	1520	12 Units

Compressors and condensers station up to 4 stages

**Operating modes, proportional band and neutral zone.**

4-stage controller for compressors or condensers. Compressor rotation by operating hours. Probe reading configurable by pressure or temperature probe. 5 relay outputs: 4 control outputs and 1 alarm output. Also with 6 digital inputs, 4 for the compressor protection thermal switches, 1 for high pressure switch and 1 for low pressure switch.

Application: Cold installations

- Power supply 12V \approx \pm 20%, 50/60Hz
- 4 Control relays SPST 2A, 250V, $\cos\varphi=1$
- 1 Alarm relay SPDT 2A, 250V, $\cos\varphi=1$
- Panel cut-out dimensions 70.5 x 28.5 mm
- Front part dimensions 75.8 x 33.8 mm
- Depth 61 mm
- 3-digit display
- Accuracy \pm 1
- Resolution (4-20mA) 0.01
- Resolution (NTC) 0.1 $^{\circ}$ C
- Scale with input 4-20mA -99.9 to +99.9
- Temperature range (NTC) -50 $^{\circ}$ C to +99 $^{\circ}$ C
- NTC or 4-20mA probe

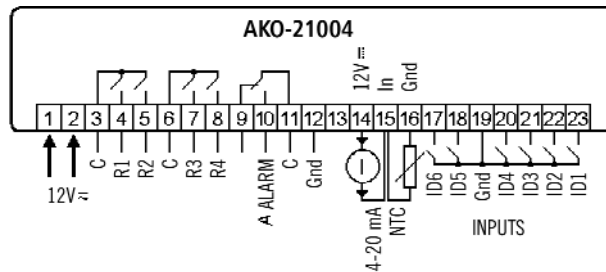

Reference	Description	Family	Pack
AKO-14540	AKODUO 4 stages	1560	1 Unit
AKO-15590	Transformer 120-230V/12V	1590	12 Units

Temperature controllers Wine thermostat

**Control designed for wine cellars.**

The two probe inputs may be linked with the two relay outputs for the thermometer, thermostats and timer applications in cold and heat installations. The second timed relay may be used for the timing. 2 operating modes:

- Temperature control (cold or heat) and timing.
- Neutral zone control.

Timing frequency up to 24 hours. Connector for RS485 module to PC. Second probe for display or alarm.

Application: Wine installations

- Temperature range -50 $^{\circ}$ C to +100 $^{\circ}$ C
- Display 3 Digits ($^{\circ}$ C/ $^{\circ}$ F)
- Resolution 0.1 $^{\circ}$ C
- Accuracy \pm 1 $^{\circ}$ C
- Type of NTC probe (1 included)
- Panel cut-out dimensions 70.5 x 28.5 mm
- Front part dimensions 75.8 x 33.8 mm
- Depth 61 mm
- Control relay R1 1 SPST 16A, 250V, $\cos\varphi=1$
- Control relay R2 1 SPDT 8A, 250V, $\cos\varphi=1$

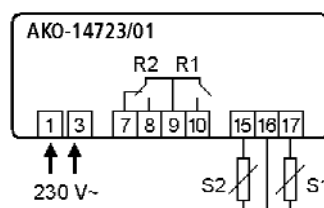

Reference	Description	Family	Pack
AKO-14723/01	230V~, for panel cut-out 70.5 x 28.5 mm	1530	12 Units

Temperature controllers Range from -50.0°C to +350.0°C, 1 relay in IP65 box



Suitable for outdoors.

It is designed to regulate the temperature of pipes, tanks, valves, processing equipment, etc. that require local control and are installed outdoors or in aggressive atmospheres, either due to dirt, humidity, corrosion, etc.

Application: Industrial installations, agricultural, etc.

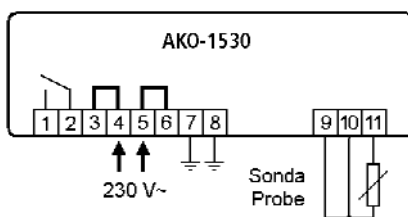

- Temperature range -50°C to +350°C
- Display 3 Digits (°C/°F)
- Resolution 0.1°C
- Accuracy ±0.5 °C
- Probe type Pt100
- Box dimensions 120 x 160 x 66 mm
- Working temperature -30°C to +60°C
- IP65 protection
- Control relay SPST 20A, 250V, cosφ=1
- Power supply 230V~ ±10%, 50/60Hz

Reference	Description	Family	Pack
AKO-1530	Thermostat up to 350°C, relay 20A SPST, without the probe	1530	5 Units
AKO-717425	Thermostat to pipe fixing support	2190	1 Unit
AKO-15595	Pt-100 probe, from -50 to 200°C, 1.5 m of cable with braid	1590	5 Units
AKO-15596	Pt-100 probe, from -200 to 600°C, in bracket 100 x 230 mm	1590	1 Unit

Temperature controllers Energy controller



Energy saving.

A controller designed to adjust the energy contribution from heating cables or other heat sources, in applications in which it must vary in line with the ambient temperature.

Its use is particularly suitable in system where, once designed and applied, the only variable that influences in the system is the ambient temperature.

Application: Electric traces, avoid freezing on ramps, terraces, etc.

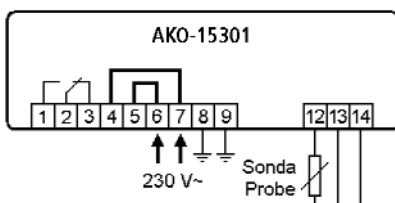

- Temperature range -40°C to +200°C
- Display 3 Digits (°C/°F)
- Resolution 0.1°C
- Accuracy ±0.5 °C
- Probe type Pt100
- Box dimensions 120 x 160 x 66 mm
- IP65 protection
- Control relay SPST 10A, 250V, cosφ= 1
- Power supply 230V~ ±10%, 50/60Hz

Reference	Description	Family	Pack
AKO-15301A	Energy regulator ambient temperature function, 10A relay	1530	1 Units
AKO-15599	Pt-100 probe for ambient temperature	1590	1 Units

Electric Heat Tracing Control EEx ed IIC T5



Electric Heat Tracing Control is approved for use in Zone 1 and 2 classified area's.

It is designed for use as adjustable control thermostats for freeze protection and temperature maintenance applications requiring pipewall or tankwall sensing. Each thermostat is available in four temperature control and bulb exposure temperature ranges. It is designed to be wall-mounted (or pipe-mounted using XP-1 stainless steel mounting bracket and has a PVC coated galvanised steel flexible capillary armoured complete with capillary gland and insulation entry device. It includes an expediter to facilitate attaching the thermostat directly on the pipe and permits two heating cables to enter and be connected within the enclosure.

Application: Electric traces

- Temperature range from 0°C to +200°C
- Maximum pipe exposure temperature +230°C
- Operating ambient temp. -45°C to +55°C
- Differential 5°C approx.
- Switch rating 16A
- Junction box with M25
- Enclosure rating IP66
- Bulb and capillary stainless steel

Reference	Description	Family	Pack
AKO-71658	Electric heat tracing control EEx ed 0 to 200°C, pipe, for 7126x and 71219	1530	1 Unit
AKO-71659	Electric heat tracing control EEx ed 0 to 200°C, wall, for 7126x and 71219	1530	1 Unit
AKO-71660	Electric heat tracing control EEx ed 0 to 200°C, pipe, for 7121x, 7124x, 7125x	1530	1 Unit
AKO-71661	Electric heat tracing control EEx ed 0 to 200°C, wall, for 7121x, 7124x, 7125x	1530	1 Unit

Temperature controllers Ice and snow centre

Guaranteeing energy savings of 80% with respect to control by means of thermostats.

This ice control centre is used in automatic heating installations for open spaces. With this system, the heating comes on only if there is a chance of freezing, for example, snow, ice or sleet and automatically turns off after thawing.

Application: To avoid ice on ramps, terraces, roofs, guttering, etc.



- Measurement of temperature, humidity, ice and snow
- Ground temperature range -40°C to +70°C
- Programme after heat from 10 min to 120 min
- Consumption meter in hours

Reference	Description	Family	Pack
AKO-80015	Ice and snow centre	1590	1 Unit
AKO-80016	Temp. and humidity probe for ramps, streets, pavements and terraces	1590	1 Unit
AKO-80020	Ice and snow probe for ramps, streets, pavements and terraces	1590	1 Unit
AKO-80030	Ice and snow ramp for roofs and guttering	1590	1 Unit
AKO-80031	Temperature probe for roofs and guttering	1590	1 Unit

Temperature controllers Thermostats for lifts



DIN rail mounting.

They are used to comply with the directive 95/16/EC in lift machinery rooms. Minimum alarm level adjusted to +5°C and maximum alarm to +40°C. 3 indication leds: Maximum, minimum alarm and temperature OK. Includes an NTC probe with 1.5 m of cable

Application: Lifts

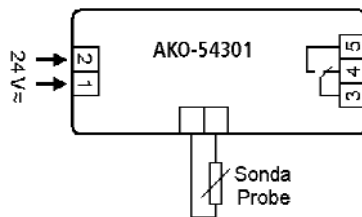

- Relay connected between 5°C and 40°C
- Accuracy $\pm 5^\circ\text{C}$
- NTC probe
- Box dimensions 18 x 90 x 58 mm (1 DIN module)
- Depth 61 mm
- Relay SPDT 8A, 24V, $\cos\phi=1$
- Power supply voltage 24 V \approx $\pm 20\%$, 50/60Hz

Reference	Description	Family	Pack
AKO-54301	24V \approx , DIN rail mounting, temp. fixed min. 5°C max. 40°C	1530	12 Units

Probes and accessories Accessories



AKO-14910



AKO-15586



AKO-155908



AKO-80004A

Reference	Description	Family	Pack
AKO-14910	Transparent lid for front protection	1590	120 Units (B)
AKO-15586	Metre of cable for extending probes	1590	100 m (A)
AKO-155908	Stainless steel sheath, 1/2" Gas thread	1590	1 Unit
AKO-80004A	Converter from Pt-100 to 4-20 mA	1590	1 Unit

(A) The metres of packaged material are the standard ones; however, we reserve the right to supply in different lengths those indicated.
(B) Minimum, indivisible pack units.

Probes and accessories Temperature probes

Reference	Description	Family	Pack
AKO-14901	NTC probe, from -50 to 100°C, 1.5 m of cable	1590	48 Units
AKO-14902	NTC probe, from -50 to 100°C, 2.0 m of cable	1590	48 Units
AKO-14903	NTC probe, from -50 to 100°C, 3.0 m of cable	1590	48 Units
AKO-14906	NTC probe, from -50 to 100°C, 6.0 m of cable	1590	24 Units
AKO-14915	NTC probe, from -50 to 100°C, stainless steel connector, 3.0 m of cable	1590	1 Unit
AKO-15561	NTC probe, from -50 to 100°C, IP68 protection, AISI 304. 1.5 m of cable	1590	10 Units
AKO-155801	PTC probe, from -50 to 150°C, 1.5 m of cable	1590	10 Units
AKO-155802	PTC probe, from -50 to 150°C, 2.0 m of cable	1590	10 Units
AKO-155803	PTC probe, from -50 to 150°C, 3.0 m of cable	1590	10 Units
AKO-155807	PTC probe, from -50 to 150°C, 7.0 m of cable	1590	10 Units
AKO-155815	PTC probe, from -50 to 150°C, 15.0 m of cable	1590	5 Units
AKO-155830	PTC probe, from -50 to 150°C, 30.0 m of cable	1590	1 Unit
AKO-15584	Pt-100 probe, from -50 to 180°C, 10.0 m of cable without braid	1590	1 Unit
AKO-15585A	Pt-100 probe, from -50 to 180°C, 2.0 m of cable without braid	1590	1 Unit
AKO-15595	Pt-100 probe, from -50 to 200°C, 1.5 m of cable with braid	1590	5 Units
AKO-15587	Pt-100 probe, from -60 to 350°C, 2.0 m of cable with braid	1590	1 Unit
AKO-15596	Pt-100 probe, from -200 to 600°C, in bracket 100 x 230 mm	1590	1 Unit
AKO-15597	Pt-100 probe, from -100 to 200°C, 2.0 m of cable	1590	1 Unit
AKO-15599	Pt-100 probe to environment temperature	1590	1 Unit
AKO-15601	J type probe, from 0 to 600°C, 3.0 m of cable	1590	1 Unit
AKO-15602	K type probe, from 0 to 1.000°C, 3.0 m of cable	1590	1 Unit
AKO-15586	Communication cable RS485, 3x0,5 mm ² shielded	1590	100 m (A)
AKO-80008	Pt-100 probe, EExd IIT6, IP65 box, to drums	1590	1 Unit
AKO-80019	Pt-100 probe, EExd IIT6, for Ex zone and pipes	1590	1 Unit
AKO-15582	Pt-100 probe, from -50 to 180°C, 2.0 m of cable without braid	1590	1 Unit

(A) The metres of packaged material are the standard ones; however, we reserve the right to supply in different lengths those indicated.

Probes and accessories Humidity probes

AKO-80040



AKO-80013



Reference	Description	Family	Pack
AKO-80013	Wall humidity probe, 10 to 95%, -5/50°C, output 4-20mA	1590	1 Unit
AKO-80040	Tubular humidity probe, 5 to 95%, -10/70°C, output 4-20mA	1590	1 Unit

Probes and accessories Transformers and power supplies

AKO-15589



AKO-15590



AKO-80014A



Reference	Description	Family	Pack
AKO-15589	Power supply converter 14 to 30V~/12V=. 5VA	1590	10 Units
AKO-15590	Transformer 120-230/12V~, 3VA	1590	12 Units
AKO-80014A	Power source 115-230V~/24V , 1A (up to 50 probes, 4-20mA type)	1590	1 Unit

Parameter servers



Tools for copying parameters

The programmers are particularly recommended for manufacturers that must adjust the equipment with just one configuration.

The portable servers allow the installer to rapidly load a pre-programmed configuration into the equipment, without having to enter the programming routine.

Reference	Description	Family	Pack
AKO-14918	Portable server for transferring parameters to the programmer	1580	10 Units
AKO-14916	Programmer for AKO-14412, AKO-14423 and AKOTIM panels	1580	1 Unit
AKO-14920	Programmer for AKO-14012 to AKO-14123	1580	1 Unit
AKO-14921	Programmer for AKO-13012 to AKO-13123	1580	1 Unit
AKO-14922	Programmer for AKO-10123 to AKO-10323	1580	1 Unit
AKO-80018	Power supply 230/12V for programmers	1580	1 Unit

