



**Pressure Transmitter
with large electroluminescent display
CPA 300**

- Ranges from 0/+10 Pa to -10 000/+10 000 Pa (according to model)
- Configurable intermediate and centre zero ranges
- Air velocity and airflow functions (optional)
- Interchangeable measuring sensor (SPI technology)
- Simultaneous display of 1 to 4 parameters
- External transmitter inputs (KIMO Class 200 and 300)
- 2 analogue outputs 4-20 mA (4 wires) or 0-10 V, RS 232, 4 6A/230 Vac RCR relays (for Ref. CPA300)
- 2 6A/230 Vac RCR relays (for Ref. CPA300HV)
- Audible alarms (buzzer - 80 dB)
- Output diagnostics
- MODBUS network RS 485 system (optional)
- Multi-directional housing made of ABS V-0 as per UL 94
- Large display 50 x 190 mm

Part number

To order, just add the codes to complete the part number :

Measuring range

- | | |
|---|--------------------|
| 1 | -100/+100 Pa |
| 2 | -500/+500 Pa |
| 3 | -1000/+1000 Pa |
| 4 | -10 000/+10 000 Pa |

For the intermediate and centre zero ranges, see "Configuration".

Power supply

- | | |
|-----------|---------|
| 24 Vac/dc | 230 Vac |
| OU | HV |

CPA30

Example : CPA 301 HV

Pressure transmitter type CPA 300, with measuring range of -500/+500 Pa, with power supply 230 Vac.

Dimensions

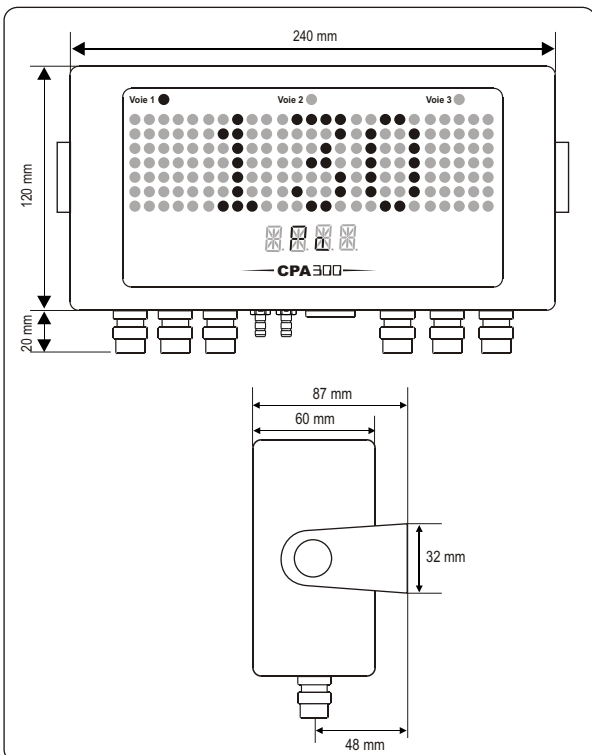

Transmitter features

Pressure

- Measuring rangesee "SPI features"
- Units of measurement.....Pa, mmH₂O, mbar, inWG, mmHG
- Accuracy*±0,5% of reading ±1 Pa (CPA 301/302/303)
±0,5% of reading ±10 Pa (CPA 304)
- Zero driftnone (see "self-calibration")
- Resolution1 Pa - 0,1 mmH₂O - 0,01 mbar - 0,01 inWG - 0,01 mmHG
- Self-calibrationpush-button or automatic (configurable)
- Type of fluid.....air and neutral gases

* All accuracies indicated in this technical datasheet were stated in laboratory conditions, and can be guaranteed for measurements carried out in the same conditions, or carried out with calibration compensation.

Functions (optional)

CPA 300 has 2 analogue outputs which correspond to the first 2 parameters displayed. You can activate 1 or 2 outputs, and for each output, you can choose between pressure, air velocity and airflow (optional functions).

Features Functions	Measuring ranges	Units and resolutions
Air velocity*	2 to 100 m/s (depends on SPI board)	0,1 m/s - 0,1 fpm
Airflow*	0 to 100 000 m ³ /h (depends on air velocity and duct dimensions)	1 m ³ /h - 0,1 m ³ /s 0,1 l/s - 1 cfm

CPA 300 can display up to 4 parameters simultaneously. The last 2 parameters are only displayed, they have no output.

* Differential probe (Pitot tube, Debimo blade...) sold separately.

Display features

- Displayelectroluminescent alphanumeric (75 x 190 mm)
protection screen made of inactinic red PMMA
- 1st line (measurement)5 digits (dot matrix 5 x 7) ℓ 50 x ℓ 190 mm
- 2nd line (unit).....4 digits (14 segments) ℓ 13 x ℓ 45 mm
- Number of channelsfrom 1 to 4 channels alternatively (each 3 sec)
- Location of channelswith 3 red identified LED
- Response time< 1 sec.

SPI system features

Interchangeable Pressure Sensor

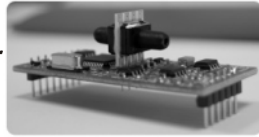

SPI board (Interchangeable Pressure Probe) includes a piezoresistive sensitive element with its digital electronic system. This system is individually adjusted and records all the calibration parameters.

Via the automatic recognition by the transmitter, this digital board is totally interchangeable. Maintenance, service and calibration are easily performed on site, with no need to stop the process.

Configurable intermediate and centre zero ranges

Probe ref.	Pressure range	Air velocity range*
SPI 100	-100/+100 Pa	2 to 10 m/s
SPI 500	-500/+500 Pa	2 to 22 m/s
SPI 1000	-1000/+1000 Pa	2 to 30 m/s
SPI 10000	-10000/+10000 Pa	2 to 100 m/s

* Air velocity ranges are given as an indication based on a differential probe DEBIMO (Cm = 1). They do not take into account temperature compensation.

The minimum configurable range is 10% of the full range.

Overpressure tolerated25 000 Pa (CPA 301, CPA 302, CPA 303)
70 000 Pa (CPA 304)

Response time1/e (63%) 0,3 sec

Typedigital

DimensionsL = 60 mm, l = 25 mm

Working temperature0 to +50°C

Storage temperature-10 to +70°C

Air velocity/airflow functions (optional)

Pressure transmitters working with a differential probe (such as débimo, Pitot tube, orifice plate...) can be configured with a square root function.

Via this function, and from the differential pressure, the transmitter can calculate air velocity and/or airflow in a duct.

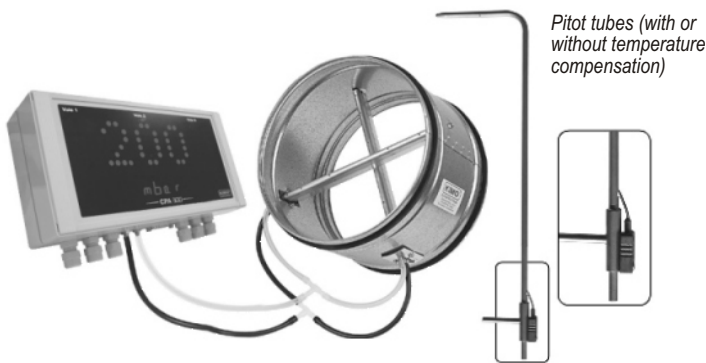

Air velocity calculation function :

$$\text{Air velocity (m/s)} = C_M \times C_C \times C_T \times \sqrt{\text{Pressure (Pa)}}$$

C_M : coefficient of the differential probe

C_C : coefficient to adapt the measuring system to the specifications of your air movement conditions

C_T : temperature compensation coefficient, with the formula below.

$$C_T = \sqrt{\frac{574,2 \times \text{temp. (°C)} + 156842,77}{101325}}$$

Airflow calculation function :

$$\text{Airflow (m}^3/\text{h)} = \text{air velocity (m/s)} \times \text{surface (m}^2) \times 3600$$

Surface : setting of duct type (rectangular or circular) and duct dimensions (in mm or in inch).

Housing features

Housingmulti-directional (30°) made of ABS

ProtectionIP 63

Fire-proof classificationV-0 as per UL 94

Dimensionssee drawing

Connection glandpolyamide for cable 7 mm max.

Fittingsbarbed fittings Ø 6,2 mm

Weight1000 g

Technical Specifications

Power supply24 Vac/Vdc ± 10%

230 Vac ± 10%, 50-60 Hz

Output2 x 4-20 mA or 2 x 0-10 V (4 wires)

maximum load : 500 Ohms (4-20 mA)

minimum load : 1 K Ohms (0-10 V)

Galvanic isolationon outputs

Consumption5 VA

Relayfor Ref. CPA300 :

4 6A/230 Vac RCR relays

for Ref. CPA300 HV :

2 6A/230 Vac RCR relays

Audible alarmsbuzzer (80 dB)

Electro-magnetical compatibility ...EN 61 326

Electrical connectionscrew terminal block for cables

Ø 1.5 mm² max

RS 485 communicationdigital : Modbus RTU system

communication speed configurable

from 2400 to 115200 Bauds

RS 232 communicationdigital : ASCII, proprietary protocol

Working temperature0 to +50°C

Storage temperature-10 to +70°C

Environmentair and neutral gases

Relays and Alarms

CPA 300 has 4 stand-alone and configuration alarms :

4 RCR relays (contacts).

CPA 300 HV has 2 stand-alone and configuration alarms :

2 RCR relays (contacts).

You can set :

- the parameter (pressure, air velocity, temperature...)
- 1 or 2 setpoints (up & down) for each alarm
- the time-delay / from 0 to 60 sec.
- the relay operation mode : positive or negative security
- the audible alarm (buzzer) activation.

Self calibration

Thanks to the temperature compensation of the gain (from 0 to 50°C) and to the self calibration, CPA 300 guarantees an excellent long-term stability, along with a great measurement accuracy.

Self calibration principle : the microprocessor drives an electro-valve that compensates for any long-term drift of the sensitive element.

Compensation is made by regular automatic adjustment of the zero. True differential pressure measurement is then made regardless of the environment conditions of the transmitter.

Electro-valve lifetime100-million cycles

Benefitno zero drift

Self calibration frequencycan be disabled or
set between 1 to 60 min.

Integration of pressure measurement

The pressure measurement element is very sensitive and reacts to pressure changes. When making measurements in unstable air movement conditions, the pressure measurement may fluctuate. The integration coefficient (from 0 to 9) makes an average of the measurements; this helps to avoid any excessive variations and guarantees a stable measurement.

Connection

- a. Analogue outputs
- b. Relays 1 and 2
- c. RS 485 connection
- d. Relays 3 and 4
- e. Power supply
- f. RS 232 connector
- g. Connection fittings
- h. Pressure connections
- i. Output selection

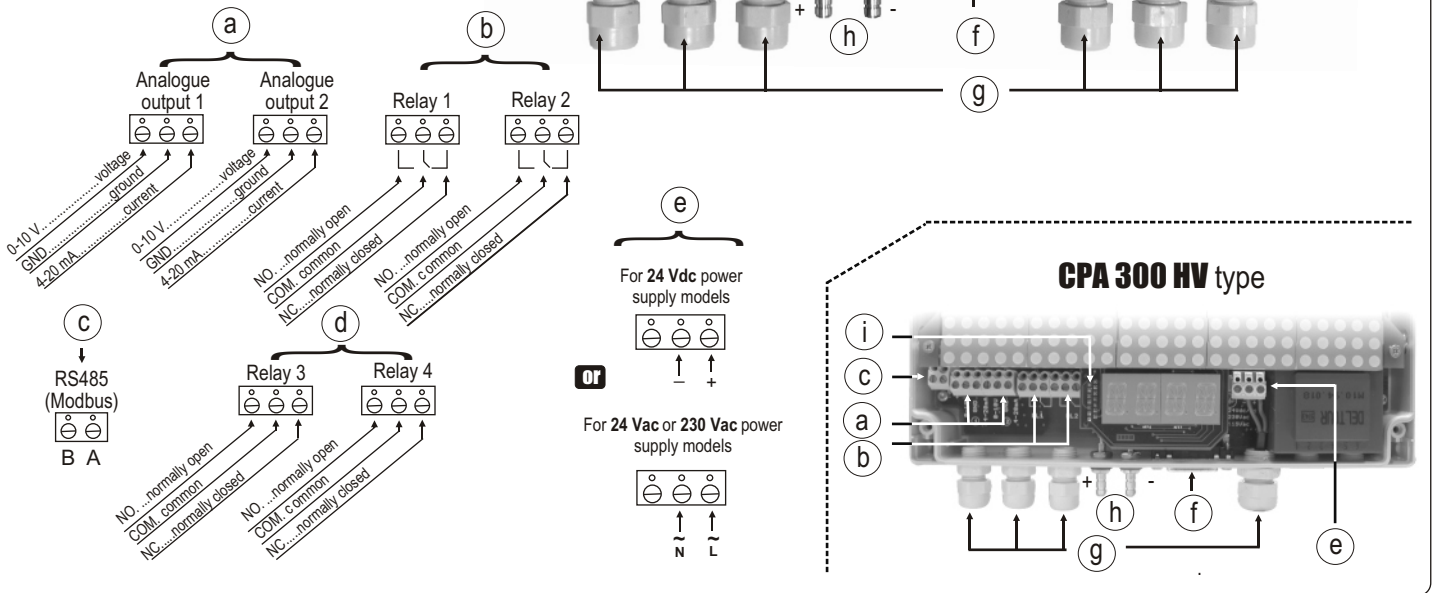

Electrical connections - as per NFC15-100 norm

⚠ This connection must be made by a qualified technician. Whilst making the connexion, the transmitter must not be energized. Before making the connection, you must first check the power supply which is indicated on the transmitter board (see ① on the connection drawing)

Power supply connection :

- For 24 Vdc power supply models :

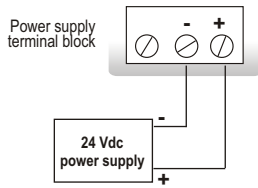

- For 24 Vac power supply models :

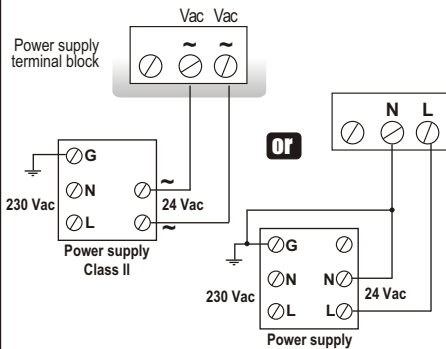

- For 230 Vac power supply models :

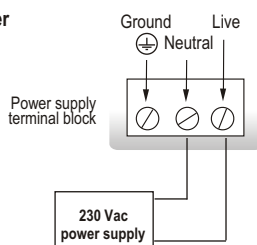

Output signal selection voltage (0-10 V) or current (4-20 mA)

The switch located on the left top of the transmitter board (see ① on connection drawing) enables selection of the required outputs.

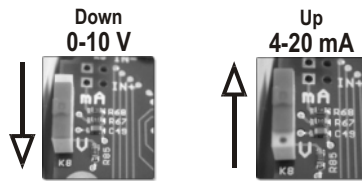

Output connexion :

- 4-20 mA current output :

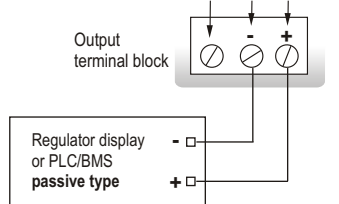

- 0-10 V voltage output :

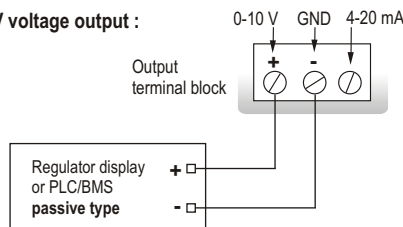

Connection of SUB-D15 RS 232 and RS 485 (see ① on connection drawing)

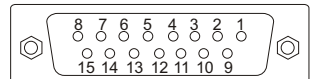

Pin #	Description
1	NC *
2	NC *
3	NC *
4	B - (RS 485)
5	A + (RS 485)
6	NC *
7	NC *
8	NC *
9	RX (RS 232)
10	NC *
11	TX (RS 232)
12	NC *
13	NC *
14	NC *
15	GND (RS 232)

⚠ Caution :
NC * --> DO NOT CONNECT

Numerical communication

RS 232 communication



• Via the RS 232 connection, CPA 300 can display 1 or 2 parameters which are measured by other Class 200 and 300 transmitters.

Benefit : CPA 300 can display (in addition to the pressure), other parameters such as temperature and humidity from a TH 200 (for example).

• Via the RS 232 connection, you can also configure your transmitter with the LCC 300 software.

- RS 232 connection cable is available in 2 m, 5 m or 10 m (maximum) lengths

Modbus network (RS 485 system)

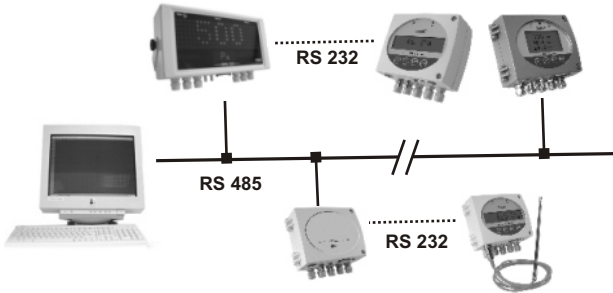

• Via CPA300, you can set up a network of transmitters/displays, on a RS 485 home bus (new or existing network).

• When a Class 200 or 300 transmitter is connected to CPA 300 (via RS 232), all the measurements can be sent to the PLC/BMS via the RS 485, with only one address.

• RS 485 digital communication is a 2-wire network, on which the transmitters are connected in parallel. They are connected to a PLC/BMS via the RTU Modbus communication system. In the same way as CPA 300 is configured with remote control, Modbus system enables to configure at distance: activate/deactivate a channel, set the measuring range of analogue outputs.

Configuration

You can configure all the parameters : units, measuring ranges, alarms, outputs, channels ... via the different methods shown below :

Via remote control (optional)

This is convenient in order to configure the transmitters located far from the user or hard to reach. Same way as with a keypad (see user manual).

Via software (optional)

Simple and user-friendly configuration. See LCC 300 user manual.

Via Modbus (optional)

Configuration of all parameters from your PC, via the supervision or data acquisition software.

Configurable analogue outputs

Configure the range according to your needs : outputs are automatically adjusted to the new measuring ranges.

Range with centre zero (-50/0/+50 Pa), with offset zero (-30/0/+70 Pa) or standard range (0 /+100 Pa) => you can configure your own intermediate ranges according to your needs, between 10% and 100% of the full scale. The minimum configurable range is 10% of the full scale.

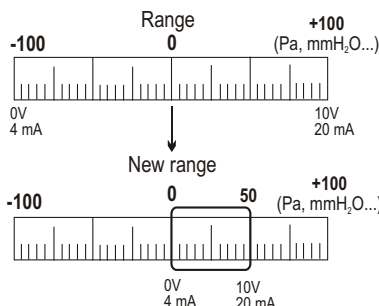

Calibration

On-site adjusting and calibration:

The professional configuration interface, with a dynamic pressure calibration bench, enables you to adjust and calibrate your transmitters directly on site or in laboratories.



Output diagnostics:

With this function, you can check with a multimeter (or on a regulator/display, or on a PLC/BMS) if the transmitter outputs work properly. The transmitter generates a voltage of 0 V, 5 V and 10 V or a current of 4 mA, 12 mA and 20 mA.



Certificate :

- CPA 300 is supplied with adjusting certificate. Calibration certificate is offered as an option.
- SPI sensitive elements (interchangeable pressure probes) are supplied with adjusting certificates.

Mounting

With the 2 screws, install the mounting bracket in horizontal position along a plane wall (see below dimensions / drilling drawing).

Put the display inside the mounting bracket, with the 2 screws.

Remove the screw covers located on the right and left side of housing, in order to have access to the 4 shutting screws. Make the electrical connection with the connection glands, with soft cable Ø 7 mm maximum. Close the housing before powering on.

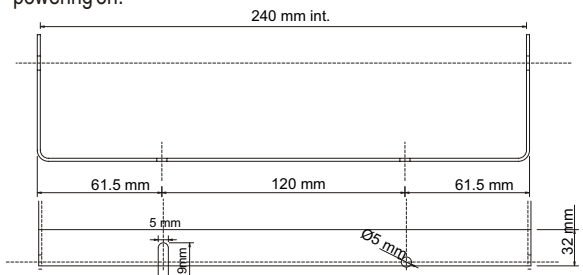
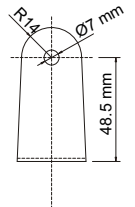

Maintenance

Avoid aggressive solvents.

Protect the transmitter and probes from any cleaning product containing formol, which may be used for cleaning rooms or ducts.

Options

- SQR/2 function (square root extraction for air velocity and airflow calculation)
- Digital output for Modbus network (RS 485 system)
- LCC 300 configuration software with RS 232 connection cable
- Infrared remote control for configuration
- Calibration certificate



Optional accessories

- Pitot tubes
- Debimo measuring blades
- Mounting brackets
- Sliding fittings
- Connection gland
- Clear tube
- Through-connections
- Pressure connections

www.kimo.fr

Distributed by :

EXPORT DEPARTMENT

Tel : +33. 1. 60. 06. 69. 25 - Fax : + 33. 1. 60. 06. 69. 29

e-mail : export@kimo.fr

